



For more accessories, please check: Surgical bed accessories list



## Max 3 Electro-Hydraulic Operating Table

**Sentek Medical Technology (Shandong) Co., Ltd.**

Add: No. 1106, 11/F, Building 2, East East, Haichao Hui Phase I, Jinan District, China  
(Shandong) Free Trade Pilot Zone

Website : [Http://: www.sentekgroup.com](http://www.sentekgroup.com)

E-mail : [frank@sentekmedical.com](mailto:frank@sentekmedical.com) Mobile : +86 157 0129 6544



If the product specifications have changed,  
it will not be notified separately.



ISO 13485



ISO 9001



# Max 3



- The electric translation distance can reach up to 310mm;
- The maximum load-bearing capacity in normal position is 300kg;
- The minimum height of 650mm can meet neurosurgery and minimally invasive surgeries;
- The performance of the electro-hydraulic braking system is stable and safe;
- The battery can satisfy 50-80 surgeries;
- Flexion and reverse flexion can be completed with one click;
- The carbon fiber bed board (optional) has excellent X-ray perspective effect and ensures imaging quality;
- The column control panel and wire controller are standard, and the foot control switch is optional.
- The push-button plugging and unplugging method (optional) is faster, and head-to-tail swapping is faster.

## Humanized clinical design

Head and leg plate interchange function



- It has the function of interchangeable head and leg plates to meet more types of surgeries;
- The structural design is simple and flexible, ensuring that the head and leg plates can be easily disassembled.

In response to the increasingly lean surgical needs, Sentek has launched the electro-hydraulic operating table Max 3 with a low table top, ultra-large lifting stroke, and ultra-long perspective space. It strives to meet the department's specialized needs for operating tables with ultimate performance and maximum performance.



## Practical manual adjustment function

- The practical and convenient manual adjustment function and electric control function are perfectly combined to help medical staff easily complete surgical positioning and achieve the optimal overall solution.

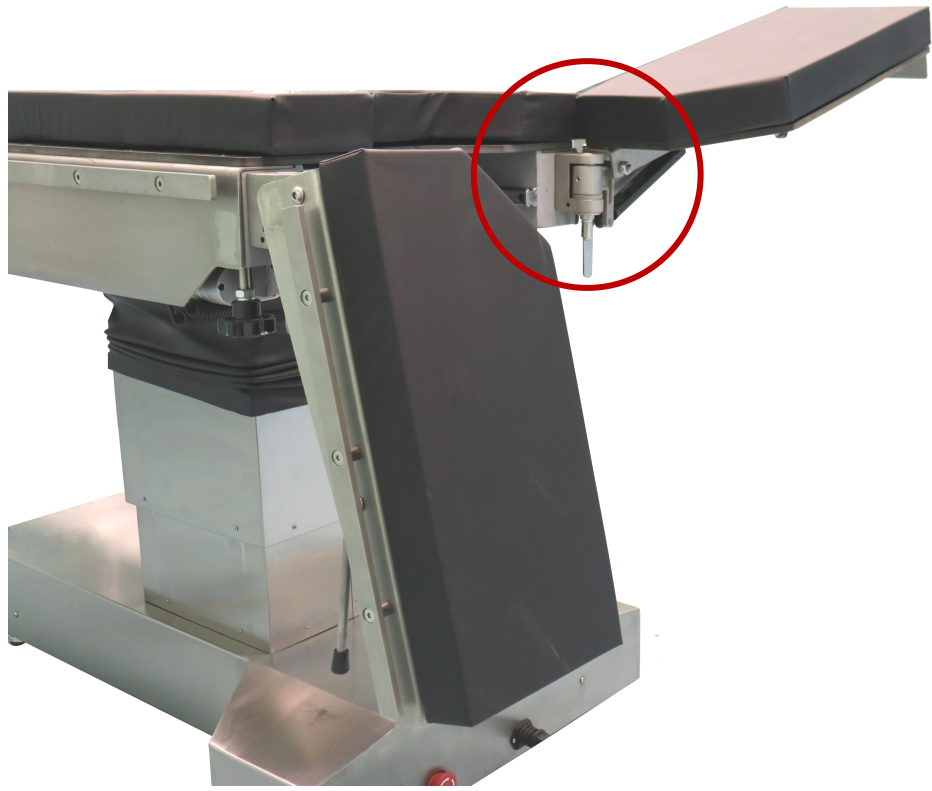

Head panel folded



Equipped with built-in liftable lumbar bridge



## Rich electric control functions

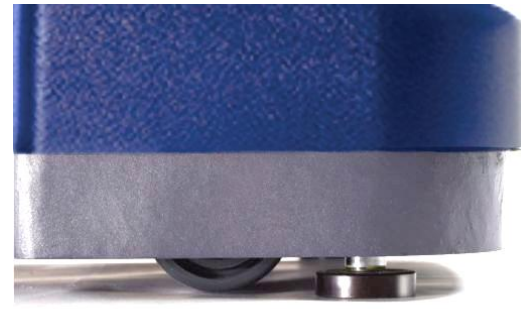

Brake status

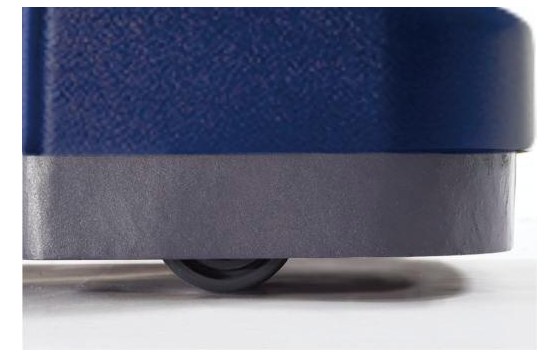
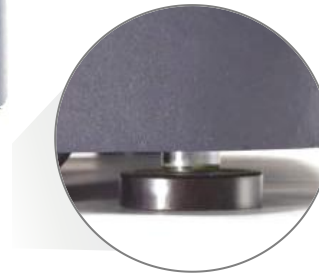

Unlocked status



Zero position/shift

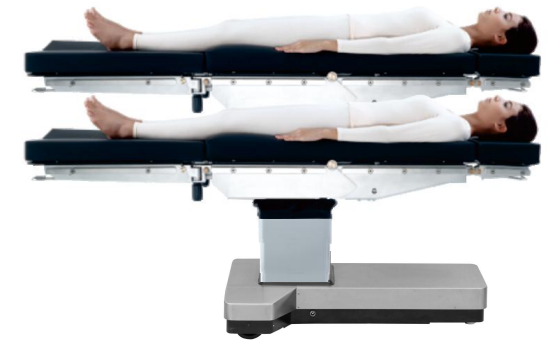

Countertop rising/tabletop lowering



Trendelenburg



Left / right leaning







Fold/down fold on back panel



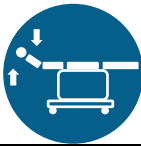



Buckling/Reverse Buckling

## Manual function

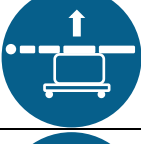
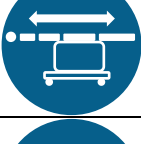
	Fold/down fold on headboard	45°/-90°
	Leg panels fold up/down	20°/-90°
	Leg abduction	90° each
	waist bridge lifting	120mm

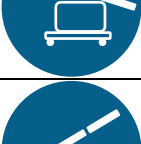
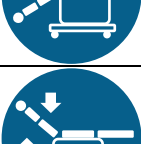
## Electric control

	Minimum bed surface	650mm
	Maximum bed surface	1010mm
	Longitudinal translation	310mm
	Left tilt of the bed	27°
	Right tilt of the bed	25°
	Trendelenburg	32°
	Reverse Trendelenburg position	30°
	Backplane folding	85°/-40°

## Standard accessories



Lithotomy position leg rest  
1 pair



Flat arm support plate  
1 pair



Anesthesia screen bracket  
1 piece



Side brackets  
1 pair



Bondage belt  
1 piece



Shoulder rack  
1 pair

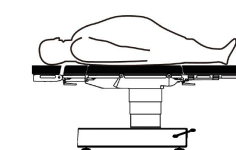

Safe Load: 300KG

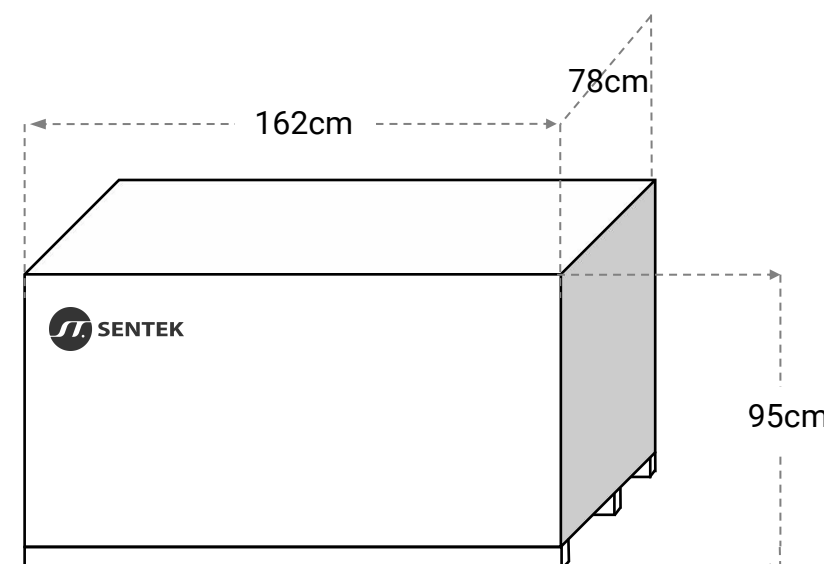

**Outer packaging material:**  
Fumigation-free wooden box

**Stacking limit:** 2

**Gross Weight:** 320KG

**Packing wooden box weight:** 22KG

**Strictly Prohibited Matters:** Tumble